

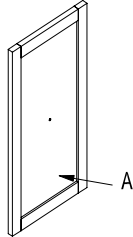

**B-Cubed 3403 Door - Double Double (Pair)**





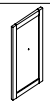

**Thank you for purchasing our products. Assembly of this product requires a phillips screwdriver.**

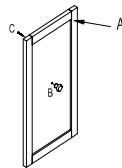
**Lay out parts on a non-abrasive surface to avoid scratching finish.**

NO.	DRAWING	DESCRIPTION	QTY
A		DOOR	2



NO.	DRAWING	DESCRIPTION	QTY
B		KNOB	2
C		KNOB SCREW	2
D		HINGE SCREWS	16
F		HINGES	4

---

**Note: The Door - Double Double (Pair) are optional doors that can be put on a 3205 Double Double.**

---

**STEP 1**  
Identify and count all parts using diagram above.

---

**STEP 2**  
Identify and count all hardware.

**STEP 3**

Insert Hinge (F) into pre-drilled holes on back of both Doors (A) - two places each door. Secure hinges using screws (D) in pre-drilled pilot holes in doors - 4 places. Attached doors to Double Double Ends by aligning screws thru the hinge mounting plate into pre-drilled pilot holes in the Ends. Tighten all screws. Note: Doors may require adjustment for proper fit. Hinges are designed to allow for some adjustment.

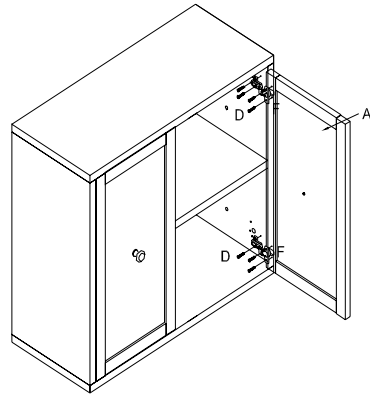

**STEP 4**

Attach Knob (B) to Door (A) using knob Screw (C )

**STEP 5**

The Double Double w/ optional doors is now complete. The Double Double w/ doors can be used as a stand alone piece or one of the cubes within a stack-able configuration.

